

MONOROTAIE E CARRELLI

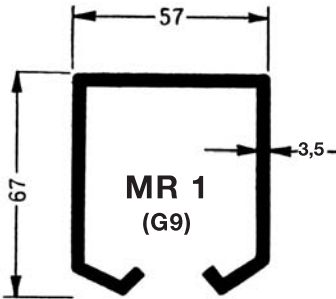

Tipo per carrelli grandi
peso al m kg 5,000

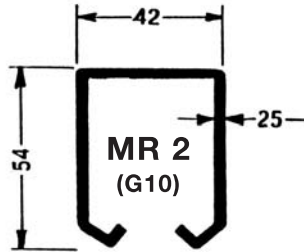

Tipo per carrelli piccoli
peso al m kg 3,180

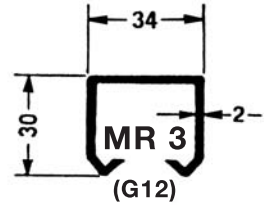

Tipo per carrelli mignon
peso al m kg 1,774

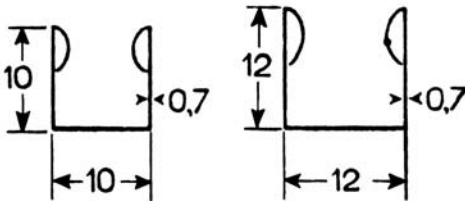

FERMAVETRO A SCATTO
LUCIDO E ZINCATO

peso m kg 0,203 peso m kg 0,240
spessore m / m 0,7

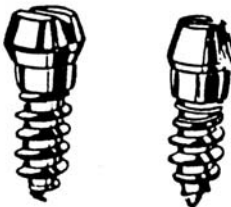

Viti in plastica e zincate autofilettanti
per fermavetri a scatto
per tipi 10 - 12

CARRELLI per MONOROTAIE

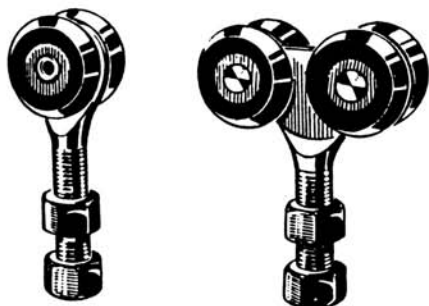

PORTATA MONOROTAIE
(con supporto ogni metro)

Carrelli grandi e piccoli a 2 e 4 ruote

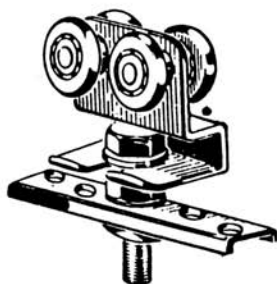

Carrelli Mignon a 4 ruote per MR 3



SSN

STAFFA SNODATA
per carrelli ns / tipi
MR 1
MR 2



GI

GUIDA INFERIORE
ad oliva con rullo ottone
Ø 15
Ø 25

GUIDA ROLLING A PAVIMENTO

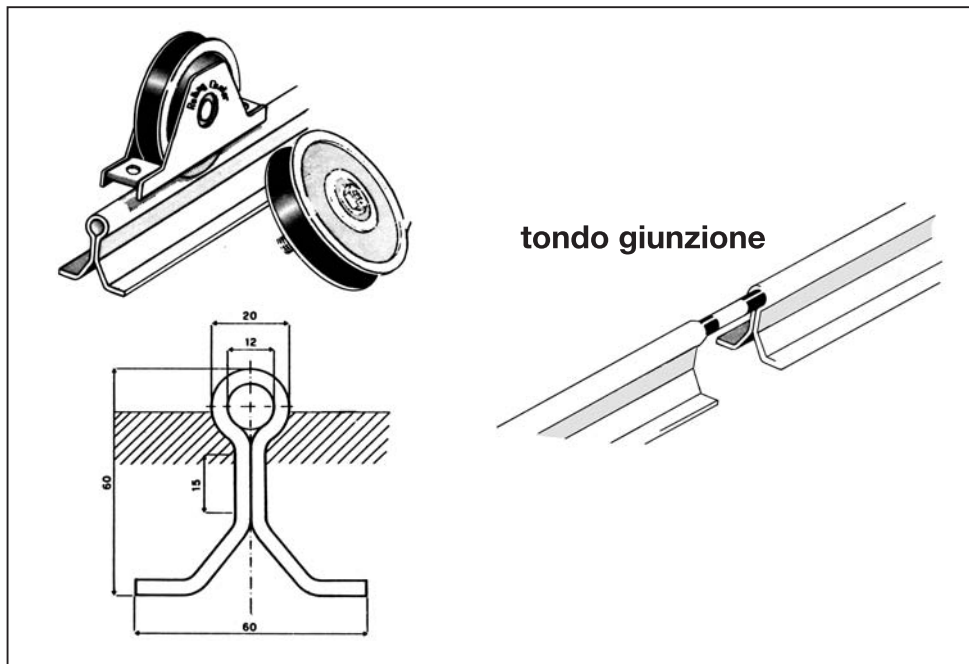

GUIDA A PAVIMENTO TASSELLARE

